

Technical
Drawing

Desenho
Técnico

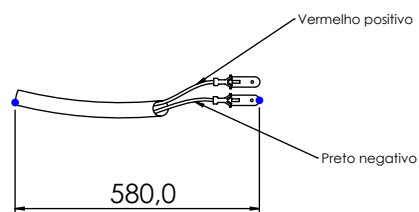
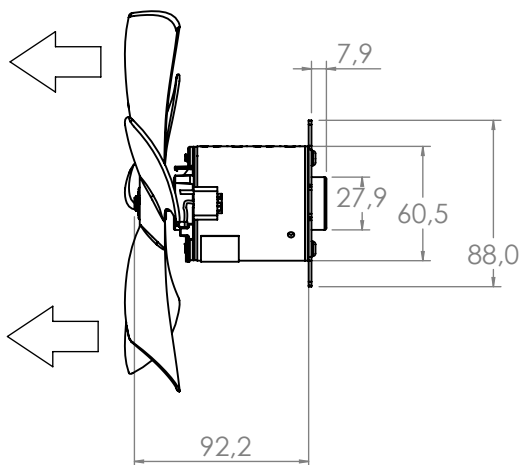
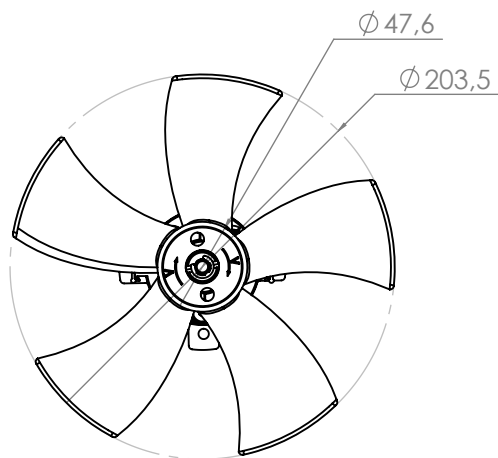

Technical
Specification

Especificação
Técnica

Imagem
Ilustrativa

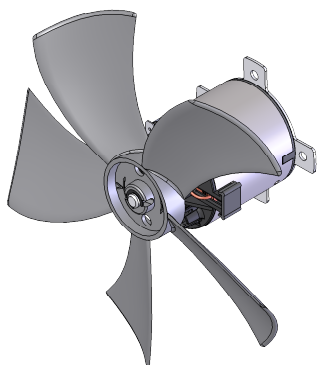

101312112

Valores Nominais	
Tensão (V)	13
Corrente (A)	2,8
RPM (min ⁻¹)	2600
Vazão (m ³ /h)	1200
Peso (Kg)	0,800

101312124

Valores Nominais	
Tensão (V)	27
Corrente (A)	1,6
RPM (min ⁻¹)	2600
Vazão (m ³ /h)	1200
Peso (Kg)	0,800

NOTAS:

-Soprante

-Blowing